

CLARK







FLEXIBLE ALL-ROUNDER

CLARK is our no-nonsense answer to the most diverse aspects of flexible working. With its straight, down-to-earth and efficient design and performant acoustics it offers a wide scope of solutions, from lounge to meeting pod. The optimal working top fit of the flip-top seater makes it a full size working space in its own right. The stitched pattern in seats and backs prevent from wrinkling and make the range perfectly suitable for public areas. The sofa modules come with powder coated steel or solid oak legs.



CLARK 2-SEATER

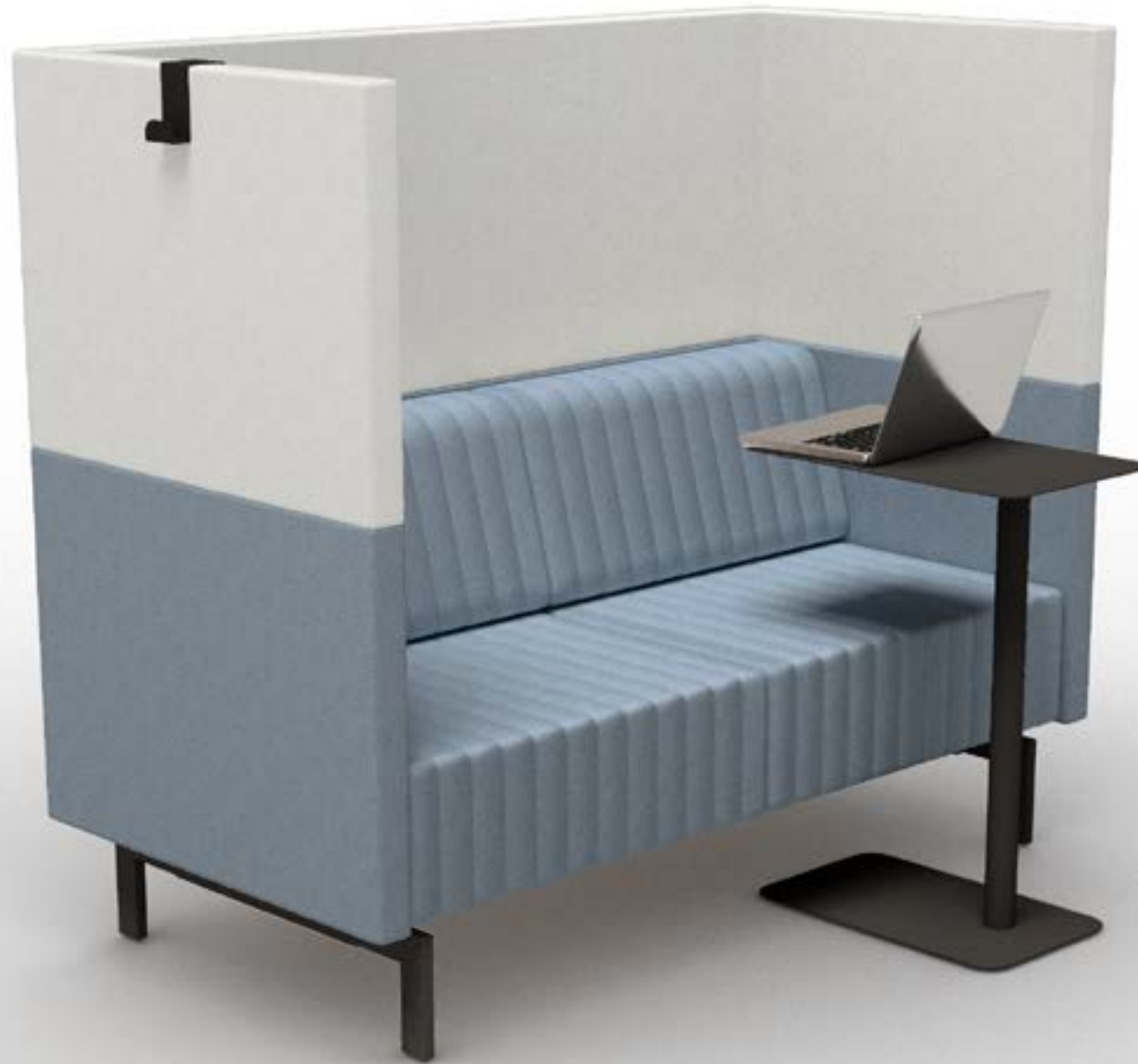

- Available with solid oak or powder coated steel legs standard black RAL 9005 or white RAL 9010 (other colours available on request).



2-SEATER STRAIGHT PANEL

HIGH • CL-2SP-H-000-0

DIMENSIONS

H = 136 cm
L = 145 cm
D = 78 cm
SH = 45 cm



2-SEATER L-PANEL LEFT

HIGH • CL-2LP-H-000-0

DIMENSIONS

H = 136 cm
L = 151 cm
D = 78 cm
SH = 45 cm



2-SEATER STRAIGHT PANEL

LOW • CL-2SP-L-000-0

DIMENSIONS

H = 77 cm
L = 145 cm
D = 78 cm
SH = 45 cm



2-SEATER L-PANEL LEFT

LOW • CL-2LP-L-000-0

DIMENSIONS

H = 77 cm
L = 151 cm
D = 78 cm
SH = 45 cm



2-SEATER U-PANEL

HIGH • CL-2UP-H-000-0

DIMENSIONS

H = 136 cm
L = 157 cm
D = 78 cm
SH = 45 cm



2-SEATER L-PANEL RIGHT

HIGH • CL-2RP-H-000-0

DIMENSIONS

H = 136 cm
L = 151 cm
D = 78 cm
SH = 45 cm



2-SEATER U-PANEL

LOW • CL-2UP-L-000-0

DIMENSIONS

H = 77 cm
L = 157 cm
D = 78 cm
SH = 45 cm



2-SEATER L-PANEL RIGHT

LOW • CL-2RP-L-000-0

DIMENSIONS

H = 77 cm
L = 151 cm
D = 78 cm
SH = 45 cm

CLARK 3-SEATER



3-seater u-panel (high) • with powder coated legs



3-seater u-panel (high) • with solid wood legs



- Available with solid oak or powder coated steel legs standard black RAL 9005 or white RAL 9010 (other colours available on request).



3-SEATER STRAIGHT PANEL

HIGH • CL-3SP-H-000-0

DIMENSIONS

H = 136 cm
L = 217 cm
D = 78 cm
SH = 45 cm



3-SEATER L-PANEL LEFT

HIGH • CL-3LP-H-000-0

DIMENSIONS

H = 136 cm
L = 223 cm
D = 78 cm
SH = 45 cm



3-SEATER STRAIGHT PANEL

LOW • CL-3SP-L-000-0

DIMENSIONS

H = 77 cm
L = 217 cm
D = 78 cm
SH = 45 cm



3-SEATER L-PANEL LEFT

LOW • CL-3LP-L-000-0

DIMENSIONS

H = 77 cm
L = 223 cm
D = 78 cm
SH = 45 cm



3-SEATER U-PANEL

HIGH • CL-3UP-H-000-0

DIMENSIONS

H = 136 cm
L = 229 cm
D = 78 cm
SH = 45 cm



3-SEATER L-PANEL RIGHT

HIGH • CL-3RP-H-000-0

DIMENSIONS

H = 136 cm
L = 223 cm
D = 78 cm
SH = 45 cm



3-SEATER U-PANEL

LOW • CL-3UP-L-000-0

DIMENSIONS

H = 77 cm
L = 229 cm
D = 78 cm
SH = 45 cm



3-SEATER L-PANEL RIGHT

LOW • CL-3RP-L-000-0

DIMENSIONS

H = 77 cm
L = 223 cm
D = 78 cm
SH = 45 cm









4-B2B SEATER STRAIGHT PANEL

HIGH • CL-4SP-H-000-0



4-B2B SEATER H-PANEL

HIGH • CL-4HP-H-000-0



4-B2B SEATER STRAIGHT PANEL

LOW • CL-4SP-L-000-0

H = 77 cm
L = 145 cm
D = 150 cm
SH = 45 cm



4-B2B SEATER H-PANEL

LOW • CL-4HP-L-000-0

H = 77 cm
L = 157 cm
D = 150 cm
SH = 45 cm

- Available with solid oak or powder coated steel legs standard black RAL 9005 or white RAL 9010 (other colours available on request).



CLARK 6-SEATER B2B



6-B2B SEATER STRAIGHT PANEL

HIGH • CL-6SP-H-000-0

DIMENSIONS

H = 136 cm
L = 217 cm
D = 150 cm
SH = 45 cm



6-B2B SEATER H-PANEL

HIGH • CL-6HP-H-000-0

DIMENSIONS

H = 136 cm
L = 229 cm
D = 150 cm
SH = 45 cm



6-B2B SEATER STRAIGHT PANEL

LOW • CL-6SP-L-000-0

DIMENSIONS

H = 77 cm
L = 217 cm
D = 150 cm
SH = 45 cm



6-B2B SEATER H-PANEL

LOW • CL-6HP-L-000-0

DIMENSIONS

H = 77 cm
L = 229 cm
D = 150 cm
SH = 45 cm

- Available with solid oak or powder coated steel legs standard black RAL 9005 or white RAL 9010 (other colours available on request).









ACOUSTIC SANDWICH SCREENS

With a height of 136 cm, the high screens of the CLARK seats offer a sheltered environment with optimum acoustics, ideally suited for concentrated work and informal meeting scenarios.

The sandwich construction made of 2 thin hardboard panels is filled inside with a thick layer of acoustic recycled cotton fiber. The sound waves created by people talking inside a CLARK meeting POD or having a phone call conversation inside a flip-top seater will be fully absorbed by the acoustic fiber inside the screens.

The sound waves can enter the acoustic fiber through the perforations of the inner hardboard panels. The outer hardboard panels will prevent these soundwaves to spread to the surrounding environment.

This benefits the user inside but also the rest of the people working in the same space at the same time.

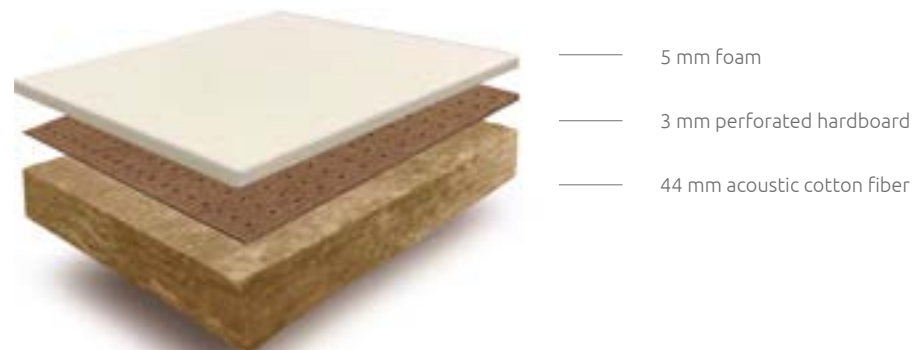



available with integrated power socket under top



flip-top (left) • with solid wood legs

CLARK 1-SEATER

CLARK 1-SEATER

CL-1UP-L-000-0

DIMENSIONS

H = 77 cm
L = 80 cm
D = 78 cm
SH = 45 cm



CLARK FLIP-TOP-SEATER

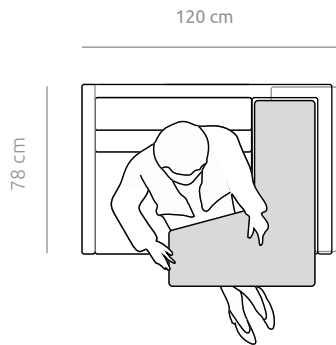

FLIP-TOP SEATER LEFT

CL-LFT-H-000-0

DIMENSIONS

H = 136 cm
L = 120 cm
D = 78 cm
SH = 45 cm

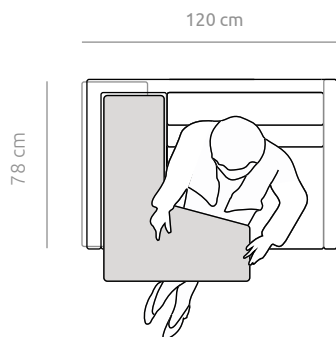

FLIP-TOP SEATER RIGHT

CL-RFT-H-000-0

DIMENSIONS

H = 136 cm
L = 120 cm
D = 78 cm
SH = 45 cm



- Available with solid oak or powder coated steel legs standard black RAL 9005 or white RAL 9010 (other colours available on request).
- Flip-top available in different finishes (see page 62).
- Available power socket inside compartment with usb port on request.

CLARK MEETING POD



pod 4-pers • clustered with optional LCD mounting brackets and cushions



78 cm

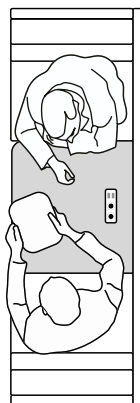

217 cm

CLARK 2-POD

OPEN • CL-2PO-H-000-0

DIMENSIONS

H = 136 cm
L = 217 cm
D = 78 cm
SH = 45 cm

- Available with solid wood or powder coated steel legs and column leg standard black RAL 9005 or white RAL 9010 (other colours available on request).
- Work top available in different finishes (see page 62).
- Different power sockets integrated in worktop available on request.
- LCD screen mounting bracket available on request.

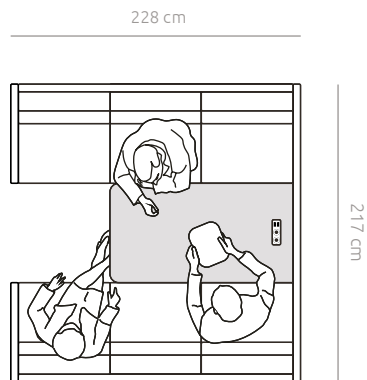

CLARK 6-POD

CLOSED • CL-6PC-H-000-0

DIMENSIONS

H = 136 cm
L = 228 cm
D = 217 cm
SH = 45 cm

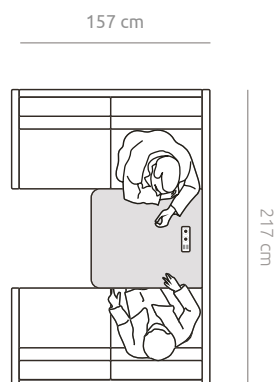

CLARK 4-POD

CLOSED • CL-4PC-H-000-0

DIMENSIONS

H = 136 cm
L = 157 cm
D = 217 cm
SH = 45 cm



- Available with solid wood or powder coated steel legs and column leg standard black RAL 9005 or white RAL 9010 (other colours available on request).
- Work top available in different finishes (see page 62).
- Different power sockets integrated in worktop available on request.
- LCD screen mounting bracket available on request.

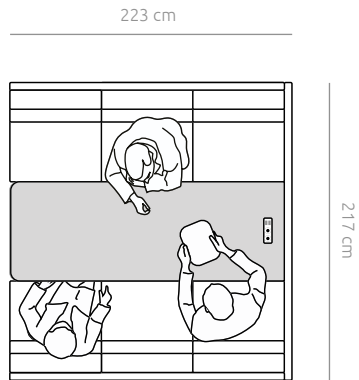

CLARK 6-POD

OPEN • CL-6PO-H-000-0

DIMENSIONS

H = 136 cm
L = 223 cm
D = 217 cm
SH = 45 cm

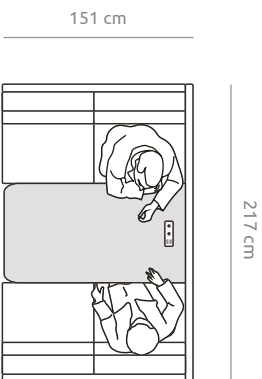

CLARK 4-POD

OPEN • CL-4PO-H-000-0

DIMENSIONS

H = 136 cm
L = 151 cm
D = 217 cm
SH = 45 cm



- Available with solid wood or powder coated steel legs and column leg standard black RAL 9005 or white RAL 9010 (other colours available on request).
- Work top available in different finishes (see page 62).
- Different power sockets integrated in worktop available on request.
- LCD screen mounting bracket available on request.

TECHNICAL SPECIFICATION

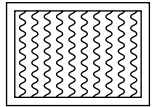

NOSAG SPRINGS

Inside the seats Nosag springs increase the comfort. These metal springs protect the quality of the surface because the flexibility of the foam on top will remain longer and wrinkles in the fabric will be avoided.



FSC CERTIFICATION

Our production plant is FSC certified and operates with a network of FSC certified suppliers.

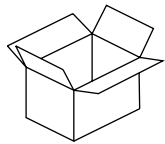

KNOCKDOWN TRANSPORT

The feet are packed separately to reduce the volume during transportation. The backrest of the 3-seater High is 'flat packed' to guarantee they fit in the elevator.

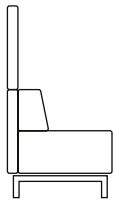

USE OF MATERIALS

The carcass is made of chipboard, plywood and hardboard panels. The legs are made of powder coated steel or solid oak wood. The entire product is covered with different types of polyether foam.



FLAMABILITY

All foam in upholstered products is covered with a fire retardant membrane that meets the BS 5852 standard.

UPHOLSTERY COMBINATION OPTIONS



- All the upholstery products of Conceptual are offered in 5 different fabric price ranges.
- All quotations will be based on these 5 ranges. Different fabric ranges can be combined for the same product.
- Special fabrics can be selected on request. For technical support contact our sales department.

OPTIONAL ACCESSORIES



YOYO LAPTOP TABLE

- Available with black and white powder coating.
- LT-XXX-YOA-XX (see table pg. 161)

DIMENSIONS ROUND - SQUARE

H = 47 cm - 67 cm
Base = D43 cm / 53 x 33 cm
Table top= D 50 cm / 55 x 35 cm



STEEL LAPTOP TABLE

- Available with black and white powder coating.
- LT-XXX-STF (see table pg. 163)

DIMENSIONS ROUND - SQUARE

H = 67 cm
Base = D40 cm / 50 x 30 cm
Table top= D 50 cm / 55 x 35 cm



SLIDE POWER SOCKET

AC-PSS-X-000-0

- cable 2m
- 2x power + 2x usb + 1x HDMI port + 1x RJ45 port



CUSHIONS

AC-CUS-X-000-0

- 50 cm X 50 cm - 70 cm X 70 cm
- Other dimensions available on request.



COAT HANGER

Available with black and white powder coating.



POWER CUSHION SQUARE

ST-PCN-S-000-0

Including:

- power socket
- 1x power + 1x USB port
- 2m cable

DIMENSIONS

H = 25 cm
W = 28 cm
L = 44 cm



POWER CUSHION ROUND

ST-PCN-R-000-0

Including:

- power socket
- 1x power + 1x USB port
- 2m cable

DIMENSIONS

D = 16,5 cm
L = 44 cm



TABLE TOP FINISHES

A. MELAMINE

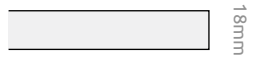

18mm



natural oak
pfleiderer R20119ML



white wash oak
pfleiderer R35013ML

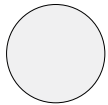

white
pfleiderer RU11026VV

POWDER COATING FINISHES

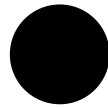

black
RAL 9005 (standard)

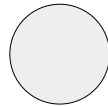

white
RAL 9010 (standard)



azure blue
RAL 5009 (on request)



purple red
RAL 3004 (on request)



broom yellow
RAL 1032 (on request)



pale green
RAL 6021 (on request)

DIMENSIONS HIGH & LOW

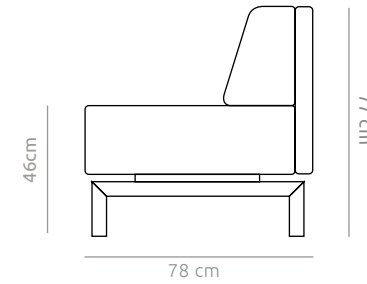

46cm

77 cm

78 cm

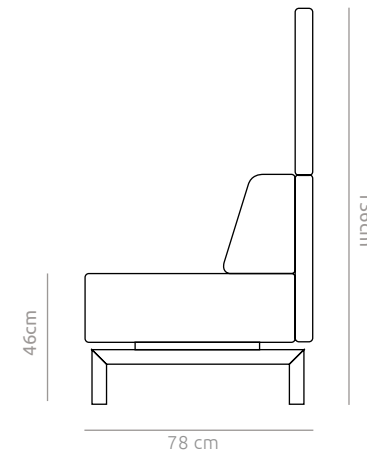

46cm

136cm

78 cm

- Other top decors available on request.
- Melamine edgeband 1mm thick in equal colour.

